



CliniMix® Lead Safe™ TMV SS Cabinet Assembly with Universal Door 20 Cold Bypass, Cold Bypass, Bottom In & Out

PRODUCT CODE:

- 101.11.70.10

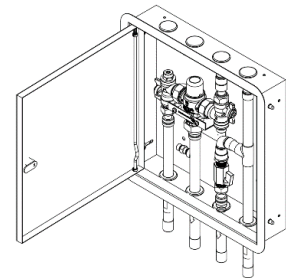

TABLE OF CONTENTS

1.0	INTRODUCTION	1
2.0	SAFETY	2
3.0	DESCRIPTION	2
4.0	DIMENSIONS	2
4.1	TECHNICAL DATA	3
4.2	FLOW SIZING GRAPH	3
5.0	WATER SUPPLY CONDITIONS	4
5.1	INTRODUCTION	4
5.2	SUPPLY PRESSURE REQUIREMENTS	4
6.0	INSTALLATION	5
7.0	COMMISSIONING	6
8.0	MAINTENANCE AND SERVICING	7
9.0	DISINFECTION	10
10.0	WARRANTY	11
11.0	TROUBLESHOOTING	12
12.0	APPENDIX	13

1.0 INTRODUCTION

- CliniMix® Thermostatic Mixing Valve Cabinets are designed to protect users from scalding or cold water shock by providing tempered water to the desired outlets.
- This stainless steel hinged cabinet kit is a lockable cabinet with 20mm copper fittings (2 in and 2 out), which allows secure installation and safe, simple maintenance of thermostatic mixing valve.
- Flat faced connections allow removal of the valve without disturbing the pipework.
- In the event of either hot or cold water supply failure the valve will shut down.
- Suitable for installation in low pressure systems and will operate with a working pressure as low as 20kPa.
- Units come complete with right angle isolating ball valve, non-return valve and strainer assemblies.
- Can be installed in any configuration with the water outlet in the horizontal or vertical position, and inlet connections can be rotated to suit inlet pipework.
- Additional bypass for cold water.
- Complies with the requirements of AS/NZS 4032.1 – Thermostatic Mixing Valves.



2.0 SAFETY

The CliniMix® Lead Safe™ TMV SS Cabinet Assembly is a high-performance valve designed to give stable and dependable operation, provided it is installed, commissioned, operated and maintained as per the recommendations outlined in this manual. It should be noted, however, that this valve should not be considered as an alternative to adequate supervision and duty of care during its use and operation.

Note: The mixing valve, inlet controls, pipe work and the surrounding area may become hot when installed which may cause burn injuries. Precautions should be taken to ensure that these surfaces cannot cause such injuries.

3.0 DESCRIPTION

This manual covers the CliniMix® Lead Safe™ TMV SS Cabinet Assembly with Universal Door 20 Bottom In & Out. These are designed to provide tempered water to the desired outlets. This mixing valve cabinet assembly is supplied with integral isolating valves, strainers and check valves and is provided with a facility for thermal disinfecting of the cold inlet side and mixed water outlet.

Avoid using heat for soldering near the mixer inlets to prevent damage to internal components.

4.0 DIMENSIONS

- Cabinet to suit rough-in wall opening area 360mm width x 360mm height x minimum 75mm – maximum 105mm depth.
- Cabinet secured using back mount or side mount.
- Measure and mark the cabinet mounting holes locations at the dimensions shown in below mounting details image.
- Suitable fasteners will need to be sourced by the installer.

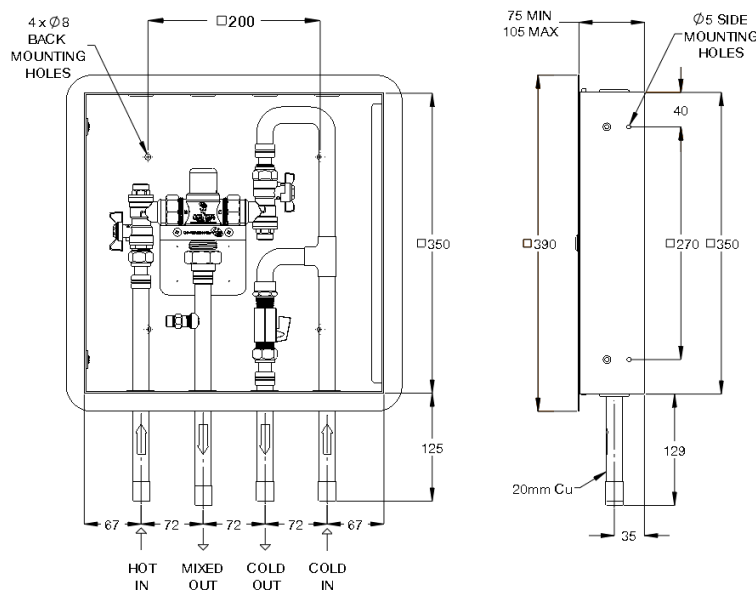
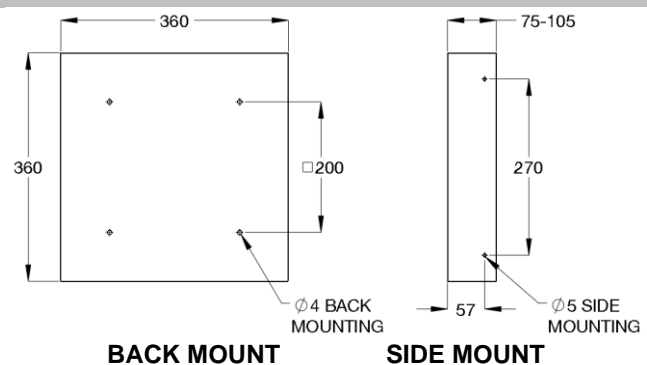

4.1 TECHNICAL DATA

MIXED OUTLET TEMPERATURE

Factory Preset Temperature (°C)	43.5
Adjustable Temperature Range (°C)	35 – 48

INLET TEMPERATURES

Cold Supply (°C)	Min	5
	Max	25
Hot Supply (°C)	Min	60
	Max	90
Temperature Differential (between supply and the outlet) for Stable Operation (°C)	Min	10
Nominal Flow Rate (LPM) (Per Graph)	Min	6

DYNAMIC INLET PRESSURES

Hot and Cold Inlet Pressures	Min	20
	Max	500

STATIC INLET PRESSURE

Hot and Cold Inlet Pressures (kPa)	Max	1000
------------------------------------	-----	------

INLET PRESSURE RATIO

Maximum Inlet Pressure Ratio for Stable Operation (Either supply) (Hot ; Cold or Cold : Hot)	6:1
--	-----

NOTE 1: for optimum operation it is recommended that the hot and cold water supply pressure be balanced to within +/- 10%

NOTE 2: Notwithstanding the above, compliance with AS/NZS3500 must be maintained.

4.2 FLOW SIZING GRAPH

The Galvin Engineering CliniMix® Thermostatic Mixing Valve is suitable for many applications. The Head-loss Characteristic for Mixed Outlet Flow rate versus Balanced Inlet Pressure is shown below in Graph below. It is important that the valve is not oversized for its intended application.

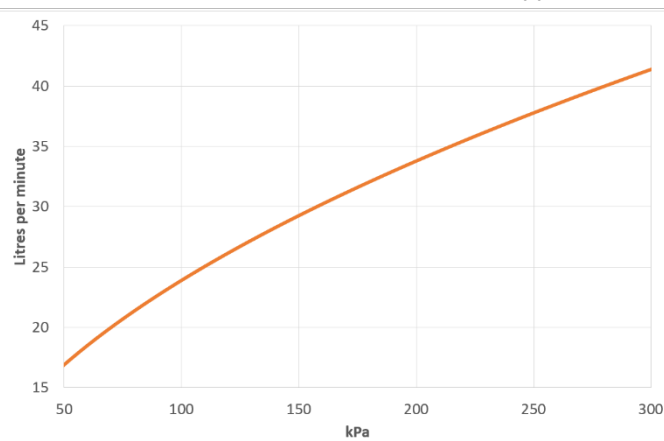

GRAPH – Head-loss Characteristics

NOTE: To ensure optimum performance the minimum outlet flow of the TMV during operation should be at least 6 litres/minute.

It is important that the valve is sized such that the flow rates from the outlets are not less than those listed AS/NZS 3500.1

The pipe-work between the TMV and the system must be sized in accordance with AS/NZS 3500.1 to ensure the water velocity in the pipe-work is within the allowed limit.

If the TMV is to be installed and operated under unequal inlet pressures, the lower inlet pressure determines the outlet flow rate. However, for optimum performance and stability it is recommended that the TMV be installed with balanced dynamic inlet pressures (+/- 10%).

5.0 WATER SUPPLY CONDITIONS

5.1 INTRODUCTION

This mixing valve cabinet assembly is manufactured to the highest standards and has approval to AS4032.1 which permits it to be installed in healthcare establishments such as hospitals, nursing homes and residential care homes. When installed in healthcare establishments the supply conditions detailed in Table 2 must be observed and the commissioning and servicing requirements detailed on section 7 & 8 must be followed.

5.2 SUPPLY PRESSURE REQUIREMENTS

This mixer is designed to be installed on all types of plumbing systems.

Hot and cold water supply pressures should be reasonably balanced; however, the mixer will function within specification on unequal pressures up to 6:1.

The mixer has integral isolating valves which permit servicing of the strainer, check valve/flow regulator and thermostatic cartridge. They are also used for thermal disinfection.

The minimum pressure for the correct thermal operation is 20kPa. However, to achieve an acceptable flow performance at very low pressures it may be necessary to remove the combined check valve and flow regulators and replace them with simple check valves to facilitate thermal disinfection.

Working Temperature Range (°C)	Min	5
	Max	90
Working Pressure Range (kPa)	Min	20
	Max	500
Maximum Static Pressure (kPa)		1000
Permitted Supply Pressure Variation		6:1

Table 2. Water supply conditions

Note: Tapware must be installed in accordance with the provisions of AS/NZS 3500. Installations not complying with AS/NZS 3500 may void the product and performance warranty provisions.



6.0 INSTALLATION

IMPORTANT: Galvin Specialised products must be installed in accordance with these installation instructions and in accordance with AS/NZS 3500, the PCA and your local regulatory requirements. Water and/or electrical supply conditions must also comply to the applicable national and/or state standards. Failing to comply with these provisions shall void the product warranty and may affect the performance of the product.

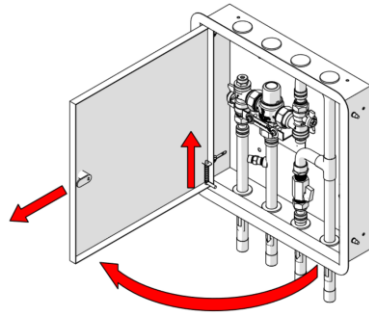

1. Remove cabinet door

1. Open the cabinet door
2. Push hinge up to allow removal of the door.
3. Remove the door from cabinet.

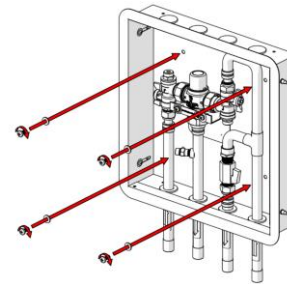

2. Secure the cabinet

- Insert cabinet into wall opening.
- Mount cabinet in wall using four fasteners, only securing hand tight.
- If side mounting, make sure door frame has clearance and can slide after fastening the cabinet.
- Adjust door frame to the wall.

Note: The cabinet must be mounted with four fasteners for stability and strength. This is critical, failure to do this may void the warranty.

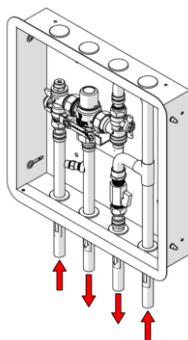

3. Connect water lines

- Before connecting to water lines, all lines must be flushed
- Remove protective vinyl cap from copper tubes.
- Join each copper tube to the correct main water line, taking note of flow direction arrows. Use suitable copper joining methods, ensuring no flash sits inside the pipeline, this will cause damage to the valves.

Note: The Galvin Engineering CliniMix Thermostatic Mixing Valve must be installed by a licensed plumber. If the valve is not installed correctly then it will not function correctly and may put the user in danger. It may also void the warranty of the valve.

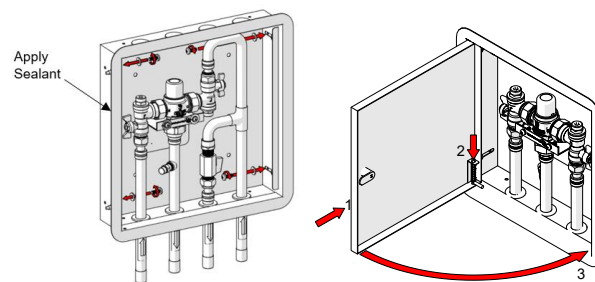

4. Testing and operation

- Adjust the door frame until sits flush with wall. Completely tighten mounting fasteners and apply sealant if necessary.
- Turn on hot and cold water supply.
- Check for any leaks
- Carry out commissioning procedure (see Section 7.0)
- Check temperature of water is correct. If not, see water temperature adjustment settings (see Section 7.0).
- Fit hinged door back into cabinet and lock with supplied key. Ensure instructions are placed in the cabinet for future service and maintenance record.

7.0 COMMISSIONING

Upon completion of the installation, the TMV must be tested and commissioned as per the procedure outlined below. The entire procedure should be read through thoroughly prior to the commissioning of the TMV. A calibrated digital thermometer having rapid response time with maximum temperature hold, a small flat bladed screwdriver, adjustable spanner and the adjusting key (supplied with the TMV) will be required to check and set out the outlet mixed temperature of the TMV.

- Ensure all outlets that will be serviced by the TMV have adequate warning signs posted to ensure that no outlet is used during commissioning.
- Open the cold supply line to the valve, and then open the hot water supply line, ensuring there are no leaks.
- Open the outlet that is serviced by the shortest length of pipe work between the mixing valve and outlet fixture.
- Allow the mixed outlet to flow for at least 60 seconds to allow the temperature to stabilise before taking a temperature reading at the outlet with a digital thermometer. The flow rate should be at least 6 L/min. The flow rate can be checked with the aid of a known size container and a stopwatch.
- If the outlet temperature requires adjustment the following steps are requires;

TEMPERATURE ADJUSTMENT

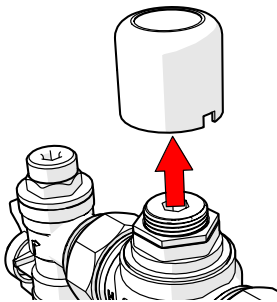

1. Using a small flat bladed screwdriver lever the protected cover off the Thermostatic Mixing Valve.

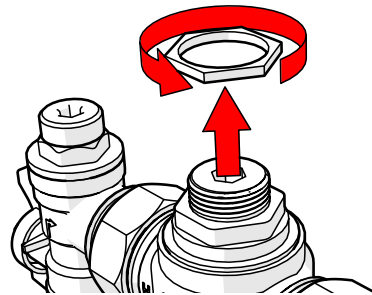

2. Release the Temperature Locking Nut with an adjustable spanner.

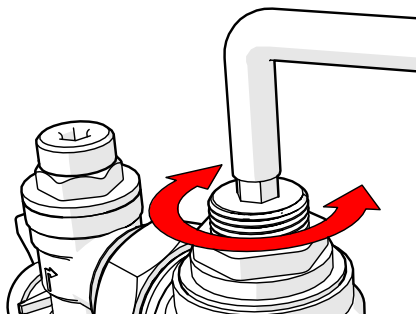

3. Fit the supplied key over the adjusting spindle (figure 3).
To increase the mixed outlet temperature, rotate the spindle anti-clockwise.
To decrease the mixed outlet temperature, rotate the spindle clockwise.

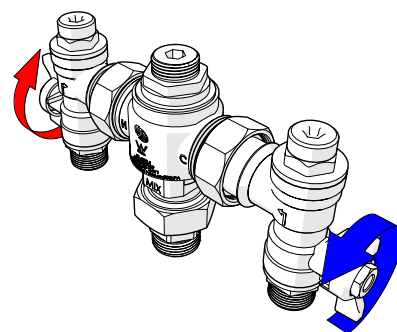

4. Allow the mixed outlet temperature to stabilize for 60 seconds and once again take a temperature reading. Repeat the procedure until the desired temperature has been reached.

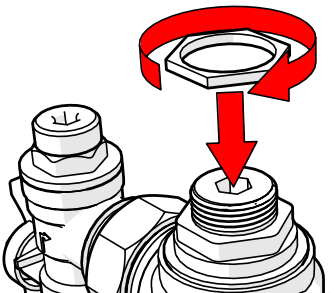
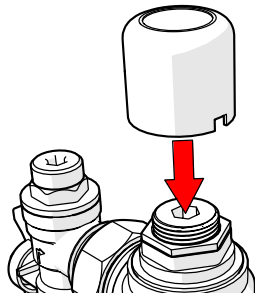
 <p>5. Retighten the Temperature Locking Nut with an adjustable spanner</p>	 <p>6. Push the top cover firmly on to the top of the valve until it 'snaps' back into place.</p>
<p>7. Check the outlet temperature is stable over a full range of flow rates and that the flow rate is adequate for the application.</p>	<p>8. Close the outlet. The TMV is now set and locked.</p>

SHUT DOWN TEST

Now that the TMV has been set and locked it is necessary to perform a shutdown check. Allow the mixed water temperature to stabilize and note the outlet temperature. While holding a digital thermometer in the outlet flow, quickly isolate the cold water supply to the valve. The outlet flow should quickly cease flowing. As a rule of thumb the flow should be less than 0.1L/min following the isolation. Monitor the maximum outlet flow temperature, and record this on the Commissioning Report (Appendix A). The temperature should not exceed that allowed by the applicable standard or code of practice for each state and territory. Restore the cold water to the TMV. After the mixed water temperature has stabilized note the outlet temperature ensuring the outlet temperature has reestablished.

Now repeat the above test, except this time quickly isolate the hot water supply to the valve. The outlet should quickly slow to a trickle. As a rule of thumb, the trickle should typically be less than 0.4L/min @ 500kPa down to less than 0.1L/min @ 100kPa following the isolation. Restore the hot water supply to the valve and measure and record the outlet temperature has stabilized ensuring the outlet temperature has reestablished.

Ensure that all details of the Commissioning Report are completed and signed by the relevant signatories. A copy of this report should be kept with the installer and owner of the premises.

The valve is now commissioned and it can be used within the technical limits of operation.

8.0 MAINTENANCE AND SERVICING

The Galvin Engineering CliniMix® Thermostatic Mixing Valve will only require minimal preventative maintenance work to ensure it operates at its optimum level of performance. The valve should be commissioned and serviced annually, unless the installed conditions dictate more frequent servicing is necessary.



ANNUAL MAINTENANCE PROCEDURE

The Galvin Engineering CliniMix® TMV should be inspected and tested annually. The valve should be given a light wipe down of the external surface. The TMV and surrounding areas should be inspected for leaks or water damage and appropriate action taken if required.

Ensure the cabinet is clean before starting. Firstly, isolate the hot and cold supplies to the TMV by closing the inlet ball isolators. Remove the inlet fitting top cover with a suitable spanner and then remove the mesh strainer. Clean with a de-scaling solvent (such as CLR), check for physical damage and then thoroughly rinsed with clean water. The strainers can then be re-installed into the valve, and the top cover replaced and tightened to a maximum torque of 15Nm into the hot and cold inlet service fitting.

If the TMV fails to shut down or fails to maintain its set temperature, then refer to the fault finding solutions outlined in Section 11.0.

The valve piston o-ring and thermostatic element / piston assembly must be replaced at intervals not exceeding 5 years.

Check that the test plugs in the top of the inlet fittings are tight and that there is no evidence of water leakage. The TMV must then be recommissioned as per Section 7.0, including temperature adjustment and the shutdown test.

INSTALLATION INSTRUCTIONS FOR THERMOSTATIC ELEMENT/PISTON ASSEMBLY

1. Ensure the cabinet is clean before starting.
2. Isolate the hot and cold supplies to the mixing valve by closing the inlet ball valves.
3. Pry off the plastic cap using a small screwdriver or similar.
4. Remove brass Top Assembly with a suitable spanner. Care must be taken to ensure that the underside of the Top Assembly does not receive even the slightest damage.
5. Gently remove the element/piston assembly.
6. Lightly grease O-rings if required. (use only potable water approved silicon-based lubricating grease such as Molykote111)
7. Insert new element/piston assembly taking extreme caution not to damage any surface of the piston.
8. Refit the TMV Top assembly back to the body and tighten to a maximum torque of 10Nm.
9. The valve must then be recommissioned as per section 7.0 including temperature adjustments and shut down test.

INSTALLATION INSTRUCTIONS FOR O-RING REPLACEMENT

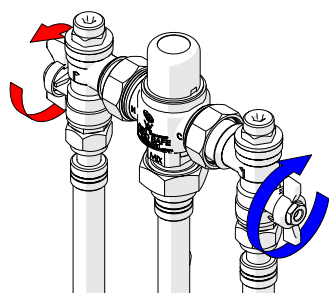

1. Ensure the cabinet is clean before starting. Isolate the hot and cold supplies to the TMV by closing the inlet isolator valves.

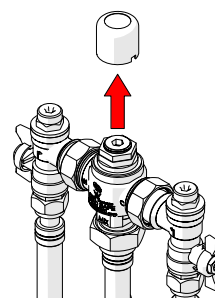

2. Remove the plastic cap.

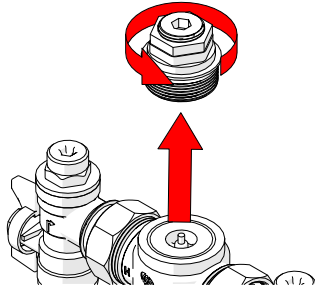

3. Unscrew brass top assembly with a suitable spanner (26mm). Care must be taken to ensure that the underside of the cap does not receive any damage.

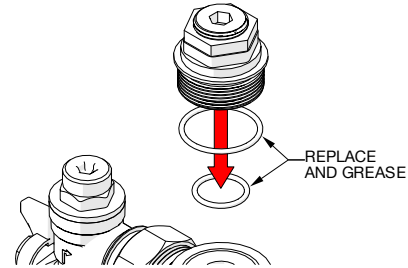

4. Remove O-ring from thread of top assembly. Replace the largest O-ring supplied in the kit (adequately grease O-rings with potable water approved silicon-based lubricating grease such as Molykote 111 before refitting).

Remove wire circlip from brass top assembly, screw out the plastic spindle and replace the smaller O-ring.

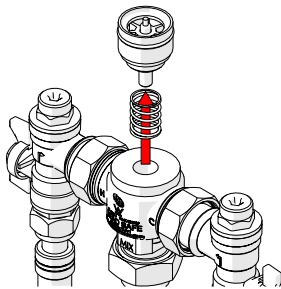

5. Carefully remove the spindle from the center of the body.

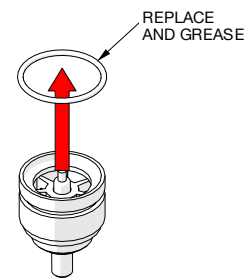

6. Remove O-ring from spindle. Replace with O-ring supplied in the kit. (adequately grease O-rings with a potable water approved silicon-based lubricating grease such as Molykote111 before refitting).

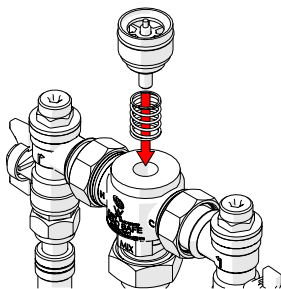

7. Insert cartridge assembly taking extreme caution not to damage any surface of the piston.

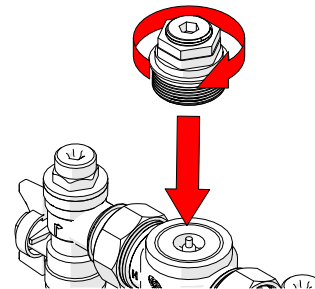

8. Refit the TMV top assembly back to the body and tighten to a maximum torque of 10Nm.

9. The valve must be recommissioned as per section 7.0 including temperature adjustments and the shutdown test.

8.1 SPARE PARTS

Part	Replacement Period
O Ring Kit	5 yearly
Thermostatic Element Assembly (incl. Thermostatic Element/Piston Assembly)	5 yearly
Face Seal Washer	As required
Inlet Fitting Strainer (two)	As required

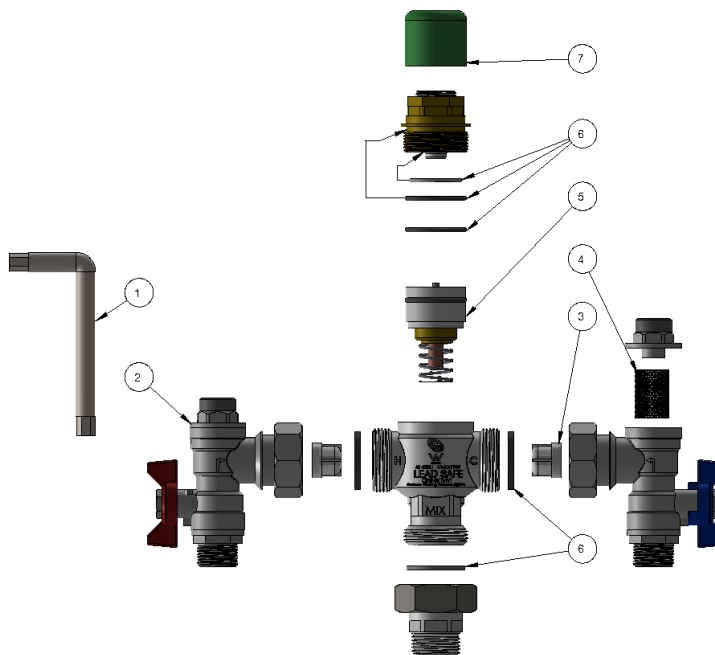

ITEM	ITEM NO.	SALES SPARE DESCRIPTION	QTY
1	WM-KEY-1	TEMPERATURE ADJUSTMENT KEY FOR WM-TMV1	1
2	WM-ISO-1	INLET ISOLATOR ELBOWS (PAIR) FOR WM-TMV1	1
3	WM-NRV-1	INLET NON-RETURN VALVE FOR WM-TMV1 (PAIR)	1
4	WM-STR-1	INLET STRAINERS FOR WM-TMV1 (PAIR)	1
5	WM-TPKIT-1	THERMOSTAT, PISTON/SHUTTLE ASSEMBLY & SPRING FOR WM-TMV1	1
6	WM-SKIT-1	SEAL & O-RING KIT FOR WM-TMV1	1
7	WM-ATC-2	ANTI TAMPER CAP FOR WM-TMV1 (GREEN)	1

NOTES: IF THE ITEM NUMBER IS NOT LISTED, THE COMPONENT IS NOT AVAILABLE INDIVIDUALLY

9.0 DISINFECTION

A thermal disinfection kit is available. For more information please visit www.galvinengineering.com.au.



10.0 WARRANTY

The Galvin Engineering CliniMix® Thermostatic Mixing Valve is guaranteed free from manufacturing faults for a period of 12 months, subject to the conditions and exclusions set out below;

GALVIN ENGINEERING PRODUCT WARRANTY

Galvin Engineering products are warranted to be free from defects in materials and/or workmanship for a period of 12 months service life, and if found by Galvin Engineering to be so defective will be replaced as set out below. If the product is sold by a party other than Galvin Engineering, then it is sold by the seller as principal and the seller has no authority from Galvin Engineering to give any additional warranty on behalf of Galvin Engineering.

The benefits of this warranty are in addition to all other rights and remedies which the purchaser may have under the Trade Practices Act or similar laws of each State and Territory in Australia.

Warranty Conditions and Exclusions

Conditions:

1. The Thermostatic Mixing Valve (TMV) must have been installed by a licensed plumber in accordance with this document and in accordance with the National Plumbing and Drainage Code AS/NZS3500 (the Code) current at the date of installation and all relevant statutory and local requirements in the State or Territory in which the product is installed.
2. Where the product is installed outside the boundaries of a metropolitan area as defined by Galvin Engineering, the cost of transport insurance and travelling shall be the purchaser's responsibility.
3. Where the TMV comprises part of a hot water system, installation of that system must be in accordance with its manufacturer's recommendation, the Code and all relevant statutory and local State or Territory requirements.
4. The TMV must be returned to Galvin Engineering together with a fully and correctly completed Galvin Engineering Warranty Claim Form.
5. Where the valve is replaced under warranty the replacement TMV carries a new warranty as detailed herein.

Exclusions:

Replacement work will be carried out as set out in the Galvin Engineering Warranty above, but the following exclusions may cause the warranty to become void, and may incur a service charge including cost of parts where:

1. Damage has been caused by accident, Acts of God, misuse, incorrect installation, incorrect installation of the water supply system of which the product forms a part of attempts to disassemble the TMV.
2. It is found that there is nothing wrong with the product
3. The failure of the TMV is due in part or in whole to faulty manufacture/installation of the hot water supply system of which the product forms a part.
4. The TMV has failed directly or indirectly as a result of excessive water pressure or temperature outside the Application Guidelines, thermal input or corrosive environment.
5. The TMV has failed due to foreign matter either from installation or the water supply.
6. The failure of the TMV is due to scale formation in the waterways of the TMV.
7. The failure of the TMV is due in part, or in whole, to installation not in conformance with the requirements of the Code.
8. Galvin Engineering reserves the right to change its specifications without prior notice and will not accept liability for any claim arising from such change.
9. Subject to any statutory provisions to the contrary, claims for damage to furniture, carpets, walls, foundations or any other consequential loss either directly or indirectly due to leakage from the TMV are also excluded from warranty cover.



11.0 TROUBLESHOOTING		
PROBLEM	CAUSE	RECTIFICATION
The desired mixed water temperature cannot be obtained.	<ul style="list-style-type: none"> Hot and cold supplies are fitted to the wrong connections Valve contains debris. Strainers contain debris. 	<ul style="list-style-type: none"> Ensure the valve has the Hot/Cold supplies fitted to the correct connections. Clean valve ensuring debris is removed and components are not damaged. Clean strainers ensuring debris is removed. Check non return device is not jammed. Clean if necessary.
The valve will not shut down during testing.	<ul style="list-style-type: none"> The hot to mix temperature differential is not high enough. Sealing seat is damaged or fouled by debris 	<ul style="list-style-type: none"> Raise hot water temperature. Replace piston O-rings Clean seat. Replace element assembly
Mix temperature unstable.	<ul style="list-style-type: none"> Debris is fouling valve. Flow rate below 6 L/min. Strainers are fouled. Systems may be fluctuating outside valve parameters 	<ul style="list-style-type: none"> Clean the valve ensuring that all debris is removed and components are not damaged. Rectify any pressure deterioration. Clean strainers Check system pressure; install pressure control valves to ensure inlet conditions are within limit
Mix temperature changing over time.	<ul style="list-style-type: none"> Inlet conditions (pressures or temperatures) are fluctuating, Strainers contain debris. 	<ul style="list-style-type: none"> Install suitable pressure control valves to ensure inlet conditions are within range. Clean strainers ensuring debris is removed.
Either full hot or cold flowing from the outlet fixture.	<ul style="list-style-type: none"> Valve is incorrectly set. Hot/Cold water has migrated to other inlet 	<ul style="list-style-type: none"> Adjust mix temperature between 35 – 48 Degrees Celsius as required. Replace faulty non-return valves
No flow from the valve outlet.	<ul style="list-style-type: none"> Hot or cold water failure. Strainers are fouled 	<ul style="list-style-type: none"> Valve functioning correctly. Restore inlet supplies and check mix temperature. Clean strainer.
Flow rate reduced or fluctuating	<ul style="list-style-type: none"> Valve or inlet fittings fouled by debris. Dynamic inlet pressures are not within those recommended limits. 	<ul style="list-style-type: none"> Check valve and inlet fittings for blockages. Ensure the dynamic inlet pressures are nominally balanced to within +/- 10%
Mixed water temperature too hot or cold.	<ul style="list-style-type: none"> Valve has been tampered with. Valve incorrectly set. Inlet temperatures are not within specified limits. 	<ul style="list-style-type: none"> Readjust valve to required set temperature. Readjust valve to required set temperature. Ensure inlet temperatures are within the specified limits.
Temperature adjuster difficult to move.	<ul style="list-style-type: none"> Adjustment at maximum mix temperature stops. Valve piston over set. 	<ul style="list-style-type: none"> Mixed water is at maximum temperature no higher mix. Wind adjuster out until set temperature required is achieved.
Hot water flows into the cold water system or vice versa.	<ul style="list-style-type: none"> Non return valves faulty. 	<ul style="list-style-type: none"> Replace non-return valves.
Valve is noisy.	<ul style="list-style-type: none"> Water velocity above velocity requirements of AS3500.1.2. 	<ul style="list-style-type: none"> Reduce water velocity.



12.0 APPENDIX

Galvin Engineering Thermostatic Mixing Valve or Tempering Valve Commissioning Report and/or Maintenance Report

Note:

1. Please use a separate form for each valve.
2. The original copy of the report is to be given to the owner/occupier and retained on site for a minimum of 7 years.

Cross off appropriate box

Thermostatic Mixing Valve Tempering Valve

Commissioning Report Maintenance Report

Name of Establishment: _____

Address of Establishment: _____

Phone Number: _____ Date: _____ Work Order #: _____

Contact Person: _____ Make & Model of Hot Water System: _____

Temperature of Hot Water to the Valve: _____ Temperature of Cold Water to the Valve: _____

Hot Water Pressure: _____ kPa Cold Water Pressure: _____ kPa

Make of Mixing Valve: _____ Model No: _____ Size: _____

Valve Location/Building: _____

Valve Identification No: _____

Total No of Valves on the Site/Building: _____

No of Outlets Serviced by this Valve: Baths () Basins () Showers ()

Other Outlets - Details _____

Valves Installed to the requirements of:

The NSW Code of Practice Plumbing and Drainage	Yes	No
The HOSPLAN Code of Practice for Thermostatic Mixing Valves in Health Care Facilities	Yes	No
The Valves manufacturers requirements	Yes	No
AS4032.3	Yes	No
The specifications and drawings for the project	Yes	No
The Local Water Supply or Authority	Yes	No

If No, give details and actions taken:

Galvin Engineering Thermostatic Mixing Valve or Tempering Valve Commissioning Report and/or Maintenance Report

Test Results

Valve considered satisfactory for use: Yes No

If No, state the reason and action taken:

Commissioning Work

It is hereby certified that all the commissioning work has been carried out by the undersigned in accordance with the requirements of the Codes of Practice indicated prior.

Date of Valve Commissioned: _____

Name of Licensed Plumber: _____ License/Cert No: _____

License Plumbers Signature: _____

Telephone No. _____

Owner/occupiers signature: _____ Date: _____

Date of Initial Service Due: _____

Galvin Engineering Thermostatic Mixing Valve or Tempering Valve Commissioning Report

Valve Location/Building : _____

Room or Area: _____

Work Order No.: _____

Warm Water Outlet Fixture No.	*Name/Type/Size and location of Outlet Fixture (Bath, Shower, Basin, Other)	Flow rate of Design Water (LPS)		Temp of Warm Water (C)	
		One Outlet in Use	**All Req'd Outlets in Use	One Outlet in Use	**All Req'd Outlets in Use
1.					
2.					
3.					
4.					
5.					
6.					
7.					
8.					
9.					
10.					
11.					

*Give details of brand and model designation.

** Commensurate with the design flow rate for the mixing valve.

Note: An accurate digital thermometer is necessary for the temperature measurements

Prescribed temperature range for warm water _____ C to _____ C

Thermal shutdown at both minimum and maximum design flow rates

(Passed/Failed) Yes No Name of Plumber: _____

License/Cert No. _____

Licensee's Signature: _____ Date: _____

Telephone Number: _____

Galvin Engineering Thermostatic Mixing Valve or Tempering Valve Commissioning/Maintenance Report

The following information is to be provided by the site manager/owner/occupier.

Valve size and installation recommended by : _____

Valves supplied by: _____

Date of Installation: _____ Drawing No. _____

Service Manual on Site: Yes No

Commissioning Tests for new installation or valve replacement. Yes

This set of testing procedures and report received and witnessed by (Print Name): _____

Temperature setting at completion of commissioning _____ C

Position: _____ Signature: _____

Date: _____

Maintenance Tests. Yes

Date of Previous Service: _____

Previous Service carried out by: _____

Reason for Maintenance Tests: _____

This Test and report Witnessed by: _____

The valve has been operating/performing satisfactorily for the previous 12 months: Yes No

Comment on monthly Temperature Tests carried out by the owner _____

Temperature setting at time of completion: _____ C

Current Report received and witnessed by:

Name: _____

Position: _____

Signature: _____ Date: _____